



KTKF-JCT

Coolant Through Cut-Off Holders for Small Parts Machining



Breaks Chips into Small Pieces with Superior Cooling Action

Discharges Coolant in Two Directions Towards Rake Surface of Insert

Superior Chip Control Performance under Pump Pressures of 145 to 435 psi

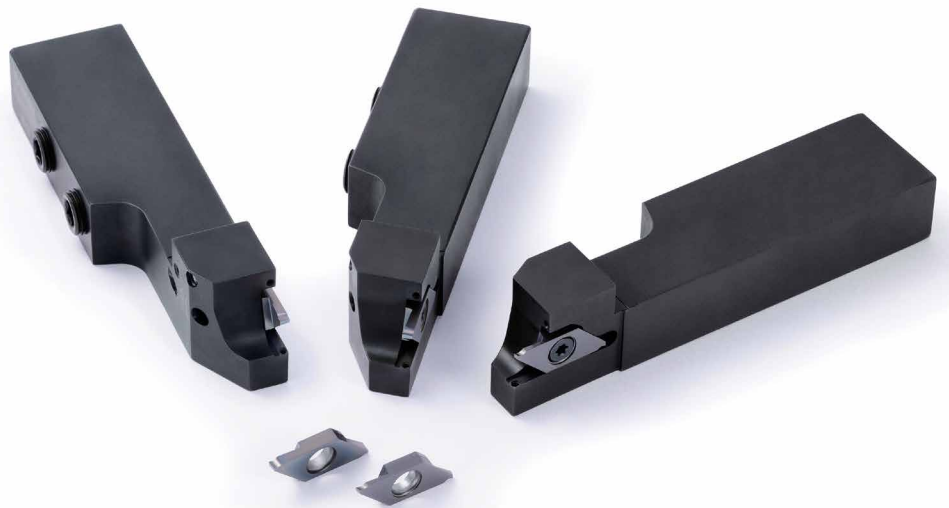

KTKF-JCT

Cut-Off Holders for Small Parts Machining, Great for High Pressure Coolant

KTKF-JCT holders break chips evenly into small pieces with excellent chip control performance when machining difficult-to-cut material and stainless steel.

1 Excellent Chip Control Performance

The KTKF-JCT discharges coolant in two directions toward rake surface of insert and breaks chips into small pieces.

Coolant Discharge Structure Comparison

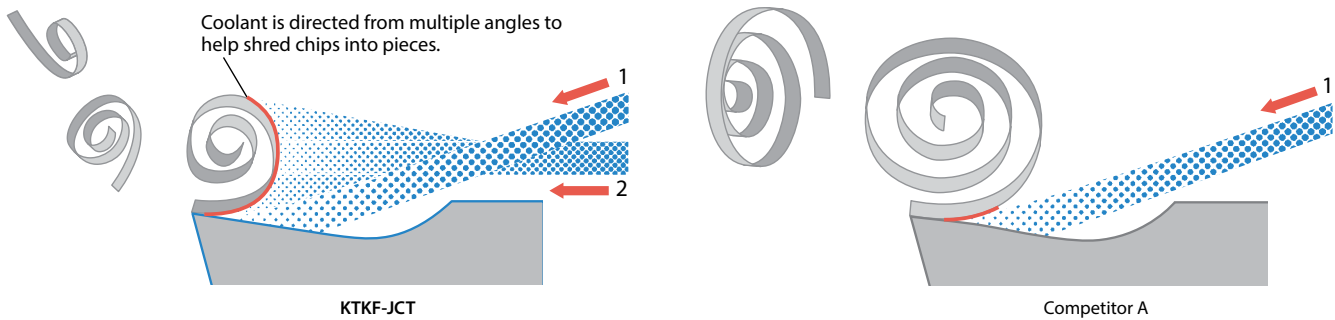

Chip Control Comparison (Internal Evaluation)

304

f (ipr)	0.0004	0.0008	0.0012
KTKF-JCT			
Competitor A			

Ti-6Al-4V

f (ipr)	0.0004	0.0008	0.0012
KTKF-JCT			
Competitor A			

Cutting Conditions: $V_c = 260$ sfm, Wet (Oil-based) Coolant Pressure: 218 psi (Internal)
Workpiece: $\varnothing 0.472$ "

Coolant Flow Rate Comparison (Internal Evaluation)

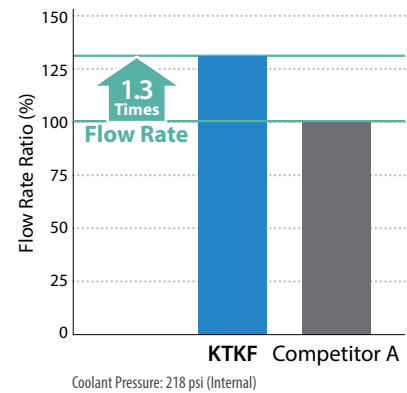

2 Superior Cooling Action Improves Tool Life

Coolant is also directed from the flank face of the insert to supply an ample amount of coolant to the tool edge area to help further suppress insert wear.

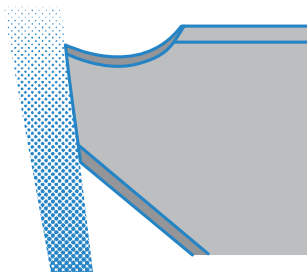

Wear Resistance Comparison (Internal Evaluation)

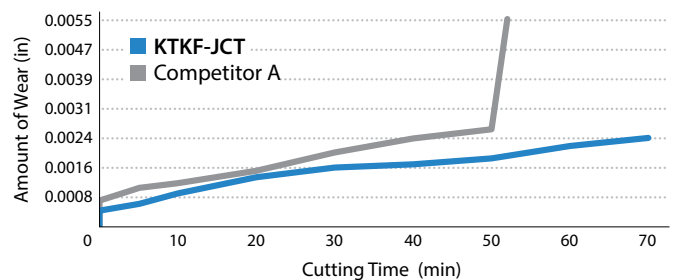

Cutting Conditions: $V_c = 330$ sfm, $f = 0.0008$ ipr, Wet (Oil-based)
Lubricating Pressure: 218 psi (Internal) Workpiece: Ti-6Al-4v $\varnothing 0.472$ "

KTKF-JCT Toolholders

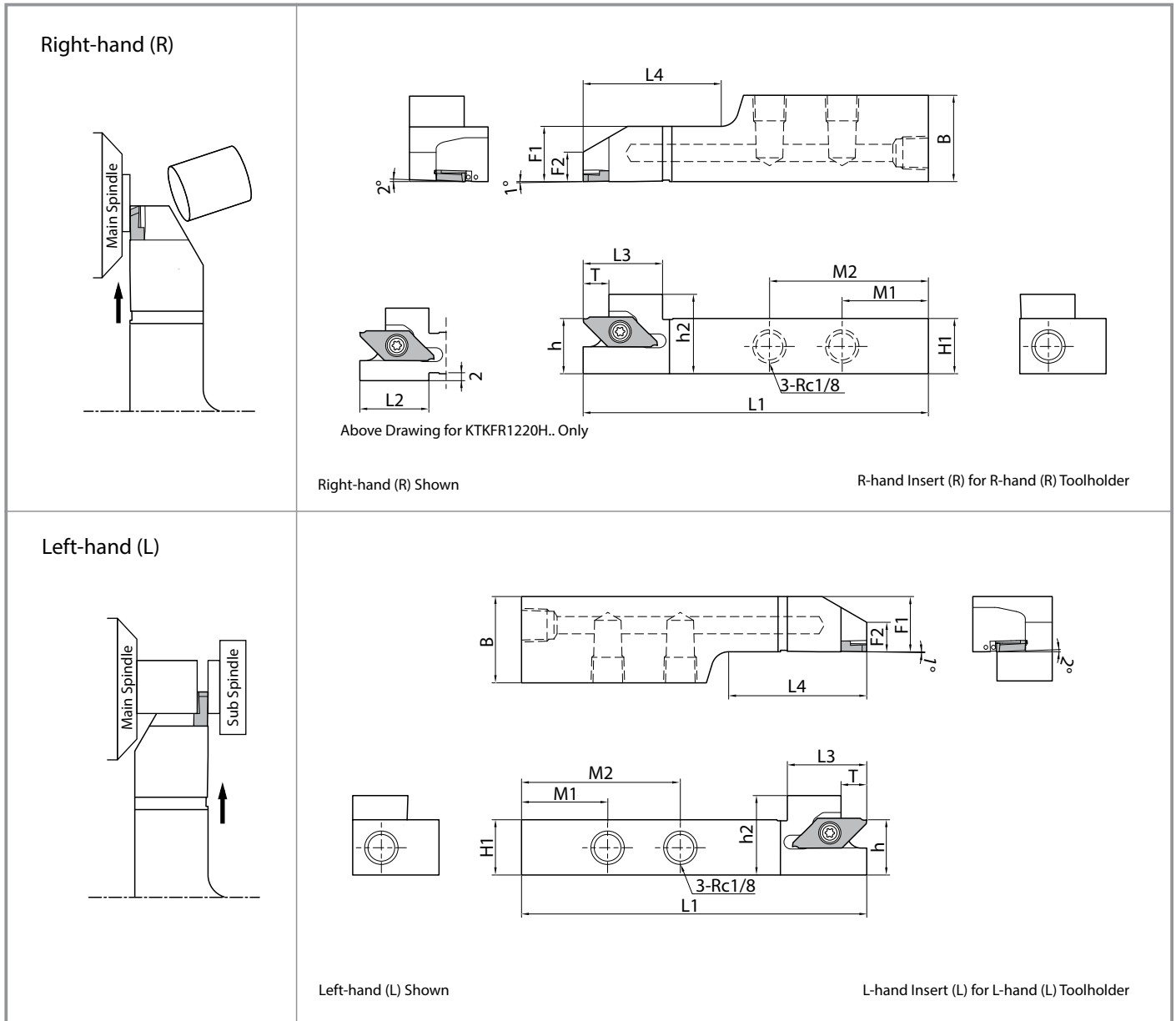

Toolholder Dimensions (Metric Size)

Part Number	Stock		Dimensions (mm)												Spare Parts		
	R	L	H1 = h	h2	B	L1	L2	L3	L4	F1	F2	T	M1	M2	Clamp Screw	Wrench	Plug
																	
KTKFR 1220H-12JCT	●		12	19	20	100	20	20	28	12	6.4	7.5	35	-	SB-4590TRWN	FT-10	GP-1
KTKF ^{R/L} 1625H-12JCT	●	●	16	23	25	100	-	23	40	16	8.5	7.5	25	46			
2025H-12JCT	●	●	20	27						20	12.5						
KTKF ^{R/L} 1625H-16JCT	●	●	16	23	25	100	-	23	40	16	8.5	9.6	25	46	SB-4590TRWN	FT-10	GP-1
2025H-16JCT	●	●	20	27					41	20	12.5						

● : U.S. Stock

Applicable Inserts  P6

Coolant Pipe Parts

Pipe parts will be required separately if internal coolant is used.

Pump Pressure: up to 2,900 psi

Pump Pressure: up to 1,088 psi if couplers are used

Without Coupler (Pump Pressure: up to 2,900 psi)

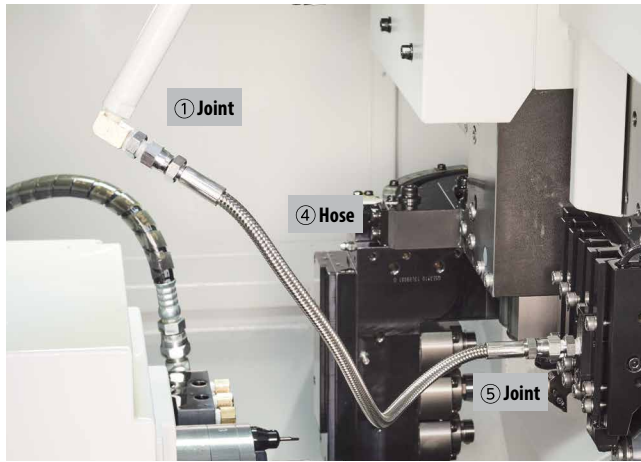

With Coupler (Pump Pressure: up to 1,088 psi)

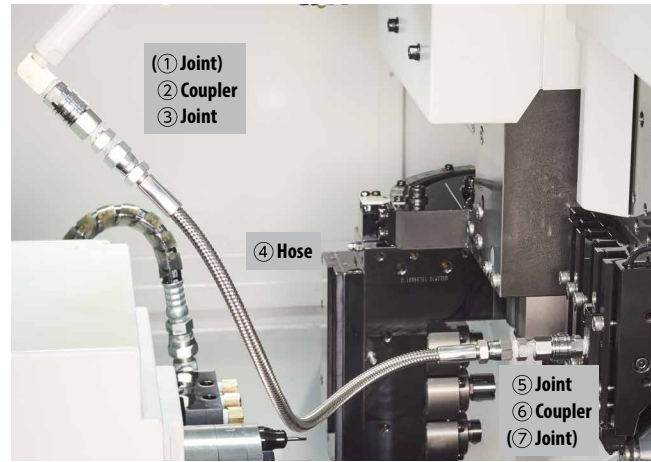

Combination Part Description Example

Part	Description
① Joint	J-ST-R1/8-G1/8
④ Hose	HS-G1/8-G1/8-500
⑤ Joint	J-ST-R1/8-G1/8

Convert the thread standards on the machine's side (Rc1/4, Rc1/8, NPT1/8, etc.) to the thread standard on the hose side (G1/8) for use.
Use sealing agents such as seal tapes when installing piping parts.

Combination Part Description Example

Part	Description
① Joint	-
② Coupler	CP-ST-R1/8, P-ST-RC1/8
③ Joint	J-ST-R1/8-G1/8
④ Hose	HS-G1/8-G1/8-500
⑤ Joint	J-ST-R1/8-G1/8
⑥ Coupler	P-ST-RC1/8, CP-ST-R1/8
⑦ Joint	-

Convert the thread standards on the machine's side (Rc1/4, Rc1/8, NPT1/8, etc.) to thread standards of the coupler (Rc1/8, etc.) or hose (G1/8) for use.
Use sealing agents such as seal tapes when installing piping parts.

Without Coupler (Pump Pressure: up to 2,900 psi)



With Coupler (Pump Pressure: up to 1,088 psi)

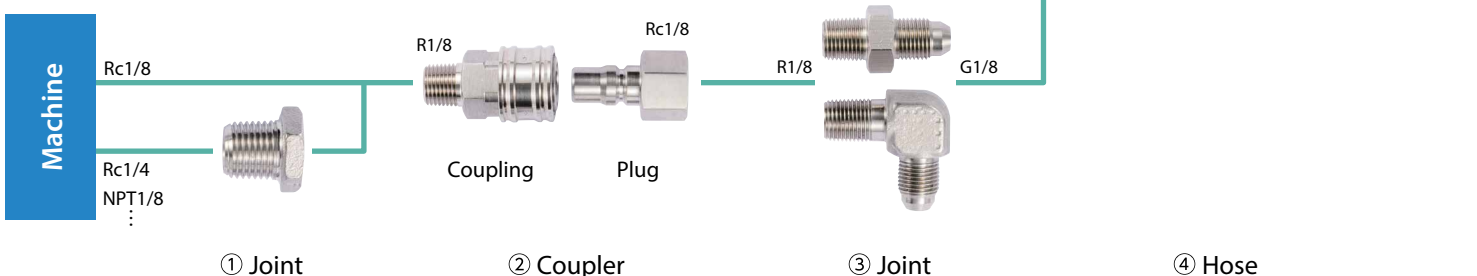





Coolant Pipe Parts

Piping Installation Parts Description

Joint (①③⑤⑦)



Pressure Resistance: up to 2,900 psi

Exterior	Description	Thread Standard	Stock
	J-ST-R1/4-G1/8	R1/4 ⇔ G1/8	●
	J-ST-NPT1/8-G1/8	NPT1/8 ⇔ G1/8	●
	J-ST-R1/8-G1/8	R1/8 ⇔ G1/8	●
	J-AN-R1/8-G1/8		●
	J-ST-R1/4-RC1/8		R1/4 ⇔ Rc1/8
	J-ST-NPT1/8-RC1/8	NPT1/8 ⇔ Rc1/8	●
	J-ST-R1/8-RC1/8	Rc1/8 ⇔ R1/8 (Extension Joint)	●

● : U.S. Stock

Coupler (②⑥)

Pressure Resistance: up to 1,088 psi

Exterior	Description	Thread Standard	Stock
	CP-ST-R1/8	R1/8	●
	P-ST-RC1/8	Rc1/8	●

● : U.S. Stock

Hose (④)

Pressure Resistance: up to 2,900 psi

Exterior	Description	Thread Standard	Total Length (mm)	Stock
	HS-G1/8-G1/8-200	G1/8	200	●
	HS-G1/8-G1/8-300		300	●
	HS-G1/8-G1/8-400		400	●
	HS-G1/8-G1/8-500		500	●
	HS-G1/8-G1/8-600		600	●
	HS-G1/8-G1/8-800		800	●

● : U.S. Stock

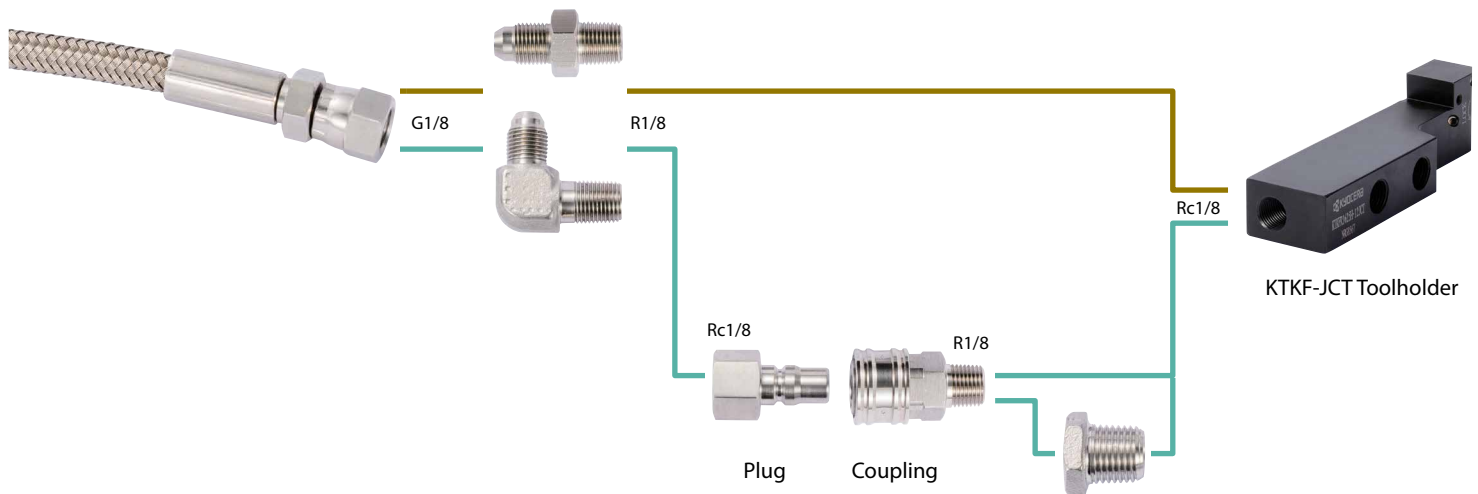











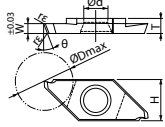

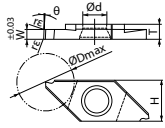

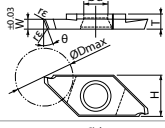

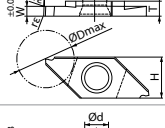

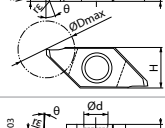
④ Hose

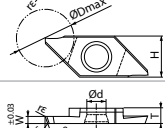
⑤ Joint

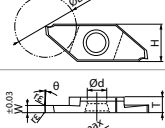
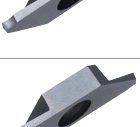
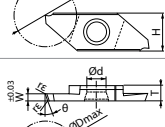
⑥ Coupler

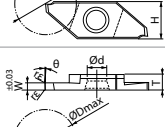
⑦ Joint (Extension Joint)

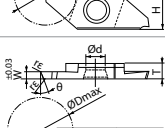
Applicable Cut-Off Inserts (TKF12 / TKF16)

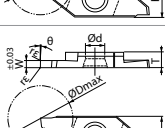
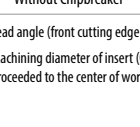
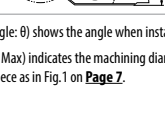
Shape		Part Number	Dimensions (mm)						Angle		Usage Classification						Applicable Toolholder
			W	ØD Max.	rε	T	H	Ød	θ	MEGACOAT NANO	MEGACOAT NANO	MEGACOAT	PVD Coated Carbide	DLC Coated Carbide	Uncoated Carbide		
										PR1425	PR1535	PR1225	PR1025	PDL025	KW10		
 Right Lead Angle		TKF12% 050-S-16DR	0.5	5	0.03	3	8.7	5	16°	●	○	○	○				
		070-S-16DR	0.7	8						●	●	○	○				
		100-S-16DR	1.0	12						●	●	●	●	○	○		
		125-S-16DR	1.25	●						●	●	○	○				
		150-S-16DR	1.5	●						●	○	○	○				
		200-S-16DR	2.0	●						●	○	○	○				
 		TKF12% 050-S	0.5	5	0.03	3	8.7	5	0°	○	●	●	○	○	○		
		070-S	0.7	8						○	●	●	○	○	○		
		100-S	1.0	12						○	●	●	○	○	○		
		125-S	1.25	○						●	●	○	○	○			
		150-S	1.5	○						●	●	○	○	○			
		200-S	2.0	○						●	●	○	○	○			
 Right Lead Angle / Tough Edge		TKF12% 100-T-16DR	1.0		0.08	3	8.7	5	16°	○	●	●					
		150-T-16DR	1.5	12						○	●	●					
		200-T-16DR	2.0	○						●	○						
 Tough Edge		TKF12% 100-T	1.0		0.08	3	8.7	5	0°	●	●	●					
		150-T	1.5	12						○	●	●					
		200-T	2.0	○						●	●						
 Right Lead Angle Without Chipbreaker		TKF12% 050-NB-20DR	0.5	5	0	3	8.7	5	20°	○	●		○	○			
		070-NB-20DR	0.7	8						○	●		○	○			
		100-NB-20DR	1.0	12						○	●		○	○			
		150-NB-20DR	1.5	○						●		○	○				
		200-NB-20DR	2.0	○						●		○	○				
 Without Chipbreaker		TKF12% 050-NB	0.5	5	0	3	8.7	5	0°	○	●		○	○			
		070-NB	0.7	8						○	●		○	○			
		100-NB	1.0	12						○	●		○	○			
		150-NB	1.5	○						●		○	○				
		200-NB	2.0	○						●		○	○				
 Right Lead Angle		TKF16% 150-S-16DR	1.5		0.05	4	9.5	5	16°	○	●	○	○	○			
		200-S-16DR	2.0	○						●	○	○	○				
 		TKF16% 150-S	1.5		0.05	4	9.5	5	0°	○	●	○	○	○			
		200-S	2.0	○						●	○	○	○				
 Right Lead Angle / Tough Edge		TKF16% 150-T-16DR	1.5		0.08	4	9.5	5	16°	○	●	○					
		200-T-16DR	2.0	○						●	○						
 Tough Edge		TKF16% 150-T	1.5		0.08	4	9.5	5	0°	○	●	○					
		200-T	2.0	○						●	○						
 Right Lead Angle / Without Chipbreaker		TKF16% 150-NB-20DR	1.5		0	4	9.5	5	20°	○	●		○	○			
		200-NB-20DR	2.0	○						●		○	○				
 Without Chipbreaker		TKF16% 150-NB	1.5		0	4	9.5	5	0°	○	●		○	○			
		200-NB	2.0	○						●		○	○				

Lead angle (front cutting edge angle: θ) shows the angle when installed in the toolholder.

Machining diameter of insert (ØD Max) indicates the machining diameter when the tool tip has proceeded to the center of workpiece as in Fig. 1 on Page 7.

● : U.S. Stock ○ : World Express (Shipping: 7-10 Business Days) ⊕ : U.S. Stock (R-hand Only) ⊖ : U.S. Stock (L-hand Only) ⊗ : World Express (R-hand Only) ⊘ : World Express (L-hand Only)

How to Read Insert Part Number (See Table 1)

TKF 12 R 050 — S — 16D R

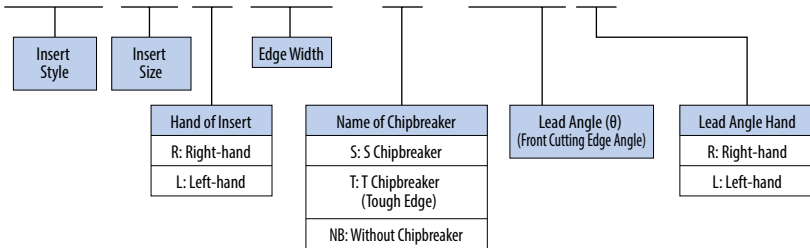

Table 1

Toolholder	Right-hand (R)	Toolholder	Left-hand (L)
Insert	Right-hand (R)	Insert	Left-hand (L)
Lead Angle	Right-hand (R)	Lead Angle	Right-hand (R)
Toolholder Hand: R		Toolholder Hand: L	

About ØDmax Machinable Diameter of Insert

When Using Main Spindle Only

Maximum machining diameter of workpiece on cut-off side ØD1 (Fig.1) follows $\text{ØD1} = \text{ØDmax}$
 Even if the cutting edge runs beyond the center line (Fig.2), the insert does not contact the workpiece, since the workpiece falls off.
 (The clearance between the insert and maximum machining diameter is kept at 0.2 mm radius)

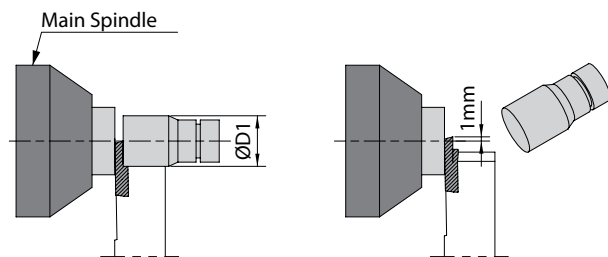

Fig. 1 (When the tool edge is at the center of workpiece)

Fig. 2 (When the tool edge has proceeded 1 mm beyond the center of workpiece)

When Using Both Main and Sub Spindles

In this case, when the cutting edge runs beyond the center line, the insert will contact the workpiece, since the workpiece does not fall off. Therefore the programmed distance beyond the center must be considered.
 Ex.) When the cutting edge is programmed to run 1 mm beyond the center of workpiece (Fig.4) the maximum machining diameter of workpiece on cut-off side ØD2 (Fig.4) = $[\text{ØDmax} - 1\text{mm} \times 2]$ (mm)
 (The clearance between the insert and the workpiece is 0.2 mm)

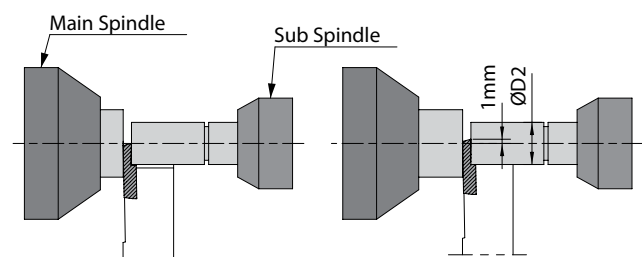

Fig. 3 (When the tool edge is at the center of workpiece)

Fig. 4 (When the tool edge has proceeded 1 mm beyond the center of workpiece)

Cut-Off Tool Edge Selection Guide

Troubleshooting

Problems	Countermeasures	Countermeasures							
		Lead Angle (θ)		Groove Width (Edge Width)		Chipbreaker Name			
		No (0°)	Yes	Narrower	Wider	S	T	NB	
Insert Fracture	Insert Fracture Prevention	Effective			Effective		Effective	Effective	Effective
Long Cutting Time	Cutting Time Reduction	Effective			Effective		Effective	Effective	Effective
Entagled Chips	Chip Entanglement Prevention	Effective		Effective		Effective			
Large Boss Remains	Small Boss Remains		Effective	Effective		Effective			
Ring Remains (Hollow Workpiece)	Prevention of Ring		Effective	Effective		Effective			
Deformation of Thin Walled Workpiece (Pipe)	Preventing Deformation		Effective	Effective		Effective			

PR1535 MEGACOAT NANO

The combination of tough substrate and special nano layer coating enables long tool life and stable machining of stainless steel.

- 1 Toughening with a New Cobalt Mixing Ratio**
* Comparison with our conventional grade
- 2 Improved Stability by Optimization and Homogenization of the Particle Matrix**
- 3 Long Tool Life and Stable Machining with MEGACOAT NANO**

23%
Fracture Toughness*

Cracking Comparison by Diamond Indentor

(In-house Evaluation)

Shock Resistance

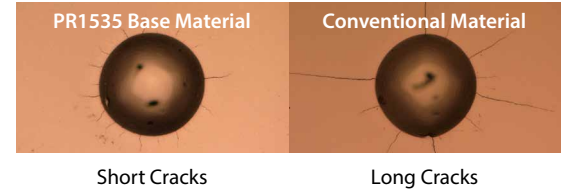

Coating Film Property

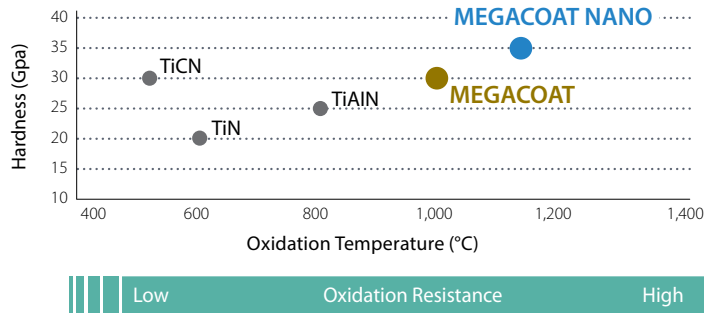

Layer Structure of MEGACOAT
PR1535 is a good solution for unstable conditions such as early fracturing and variable tool life during steel machining.

Recommended Cutting Conditions

★ 1st Recommendation ☆ 2nd Recommendation

Workpiece	Recommended Insert Grade (Vc: sfm)						TKF12						TKF16		Notes
	MEGACOAT NANO		MEGACOAT	PVD Coated Carbide	DLC Coated Carbide	Uncoated Carbide	Edge Width W (mm)						Edge Width W (mm)		
	PR1425	PR1535	PR1225	PR1025	PDL025	KW10	0.5	0.7	1.0	1.25	1.5	2.0	1.5	2.0	
Carbon Steel	★ 230 - 560 (160 - 460)	☆ 230 - 490 (160 - 390)	☆ 230 - 490 (160 - 390)	☆ 200 - 430	-	-	0.0004-0.0008	0.0004-0.0012	0.0004-0.0016 (0.0004-0.0020)	0.0004-0.0016	0.0004-0.0016 (0.0008-0.0039)	0.0004-0.0016 (0.0008-0.0039)	0.0008-0.0028 (0.0008-0.0039)	0.0008-0.0028 (0.0008-0.0039)	Wet
Alloy Steel	★ 230 - 560 (160 - 460)	☆ 230 - 490 (160 - 390)	☆ 230 - 490 (160 - 390)	☆ 200 - 430	-	-	0.0004-0.0008	0.0004-0.0012	0.0004-0.0016 (0.0004-0.0020)	0.0004-0.0016	0.0004-0.0016 (0.0008-0.0039)	0.0004-0.0016 (0.0008-0.0039)	0.0008-0.0028 (0.0008-0.0039)	0.0008-0.0028 (0.0008-0.0039)	
Stainless Steel	☆ 200 - 460 (130 - 390)	★ 200 - 390 (130 - 330)	☆ 200 - 390 (130 - 330)	☆ 160 - 330	-	-	0.0002-0.0006	0.0004-0.0008	0.0004-0.0008 (0.0004-0.0012)	0.0004-0.0008	0.0004-0.0008 (0.0004-0.0020)	0.0004-0.0008 (0.0004-0.0020)	0.0004-0.0016 (0.0004-0.0020)	0.0004-0.0016 (0.0004-0.0020)	
Cast Iron	-	-	-	-	-	★ 160 - 330	0.0004-0.0012	0.0004-0.0016	0.0004-0.0020	0.0004-0.0020	0.0004-0.0020	0.0004-0.0020	0.0008-0.0031	0.0008-0.0031	
Aluminum	-	-	-	-	★ 660 - 1,640	☆ 660 - 1,470	0.0004-0.0012	0.0004-0.0016	0.0004-0.0020	0.0004-0.0020	0.0004-0.0020	0.0004-0.0020	0.0008-0.0031	0.0008-0.0031	
Brass	-	-	-	-	-	★ 330 - 660	0.0004-0.0012	0.0004-0.0016	0.0004-0.0024	0.0004-0.0024	0.0004-0.0024	0.0004-0.0024	0.0008-0.0039	0.0008-0.0039	

Recommendations in Parentheses () : Tough Edge Type (TKF.T.)



KYOCERA Precision Tools

102 Industrial Park Road
Hendersonville, NC 28792
Customer Service | 800.823.7284 - Option 1
Technical Support | 800.823.7284 - Option 2



Official Website | www.kyoceraprecisiontools.com
Distributor Website | mykpti.kyocera.com
Email | cuttingtools@kyocera.com